

IRF5851

HEXFET® Power MOSFET

- Ultra Low On-Resistance
- Dual N and P Channel MOSFET
- Surface Mount
- Available in Tape & Reel
- Low Gate Charge

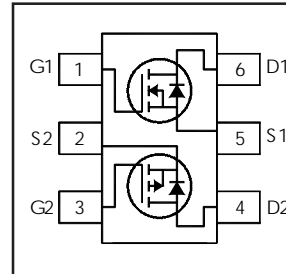

	N-Ch	P-Ch
V_{DS}	20V	-20V
$R_{DS(on)}$	0.090Ω	0.135Ω

Description

These N and P channel MOSFETs from International Rectifier utilize advanced processing techniques to achieve the extremely low on-resistance per silicon area. This benefit provides the designer with an extremely efficient device for use in battery and load management applications.

This Dual TSOP-6 package is ideal for applications where printed circuit board space is at a premium and where maximum functionality is required. With two die per package, the IRF5851 can provide the functionality of two SOT-23 packages in a smaller footprint. Its unique thermal design and $R_{DS(on)}$ reduction enables an increase in current-handling capability.

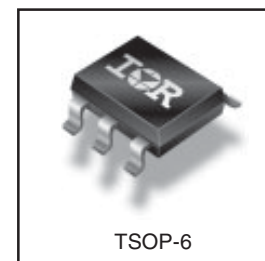

Absolute Maximum Ratings

	Parameter	Max.		Units
		N-Channel	P-Channel	
V_{DS}	Drain-to-Source Voltage	20	-20	A
$I_D @ T_A = 25^\circ\text{C}$	Continuous Drain Current, $V_{GS} @ 10\text{V}$	2.7	-2.2	
$I_D @ T_A = 70^\circ\text{C}$	Continuous Drain Current, $V_{GS} @ 10\text{V}$	2.2	-1.7	
I_{DM}	Pulsed Drain Current ①	11	-9.0	
$P_D @ T_A = 25^\circ\text{C}$	Power Dissipation ③	0.96		W
$P_D @ T_A = 70^\circ\text{C}$	Power Dissipation ③	0.62		
	Linear Derating Factor	7.7		mW/°C
V_{GS}	Gate-to-Source Voltage	± 12		V
T_J, T_{STG}	Junction and Storage Temperature Range	-55 to + 150		°C

Thermal Resistance

	Parameter	Typ.	Max.	Units
$R_{\theta JA}$	Maximum Junction-to-Ambient ③	—	130	°C/W

Electrical Characteristics @ T_J = 25°C (unless otherwise specified)

Parameter	Description		Min.	Typ.	Max.	Units	Conditions
V _{(BR)DSS}	Drain-to-Source Breakdown Voltage		20	—	—	V	V _{GS} = 0V, I _D = 250μA V _{GS} = 0V, I _D = -250μA
ΔV _{(BR)DSS} /ΔT _J	Breakdown Voltage Temp. Coefficient		—	0.016	—	V/°C	Reference to 25°C, I _D = 1mA Reference to 25°C, I _D = -1mA
R _{DS(on)}	Static Drain-to-Source On-Resistance		—	—	0.090	Ω	V _{GS} = 4.5V, I _D = 2.7A ② V _{GS} = 2.5V, I _D = 2.2A ② V _{GS} = -4.5V, I _D = -2.2A ② V _{GS} = -2.5V, I _D = -1.7A ②
			—	—	0.120		
			—	—	0.135		
			—	—	0.220		
V _{GS(th)}	Gate Threshold Voltage		0.60	—	1.25	V	V _{DS} = V _{GS} , I _D = 250μA V _{DS} = V _{GS} , I _D = -250μA
g _{fs}	Forward Transconductance		5.2	—	—	S	V _{DS} = 10V, I _D = 2.7A ② V _{DS} = -10V, I _D = -2.2A ②
I _{DSS}	Drain-to-Source Leakage Current		—	—	1.0	μA	V _{DS} = 16V, V _{GS} = 0V V _{DS} = -16V, V _{GS} = 0V V _{DS} = 16V, V _{GS} = 0V, T _J = 70°C V _{DS} = -16V, V _{GS} = 0V, T _J = 70°C
			—	—	-1.0		
			—	—	25		
			—	—	-25		
I _{GSS}	Gate-to-Source Forward Leakage	N-P	—	—	±100		V _{GS} = ±12V
Q _g	Total Gate Charge		—	4.0	6.0	nC	N-Channel I _D = 2.7A, V _{DS} = 10V, V _{GS} = 4.5V ②
			—	3.6	5.4		
Q _{gs}	Gate-to-Source Charge		—	0.95	—	nC	P-Channel I _D = -2.2A, V _{DS} = -10V, V _{GS} = -4.5V ②
			—	0.66	—		
Q _{gd}	Gate-to-Drain ("Miller") Charge		—	0.83	—	nC	N-Channel V _{DD} = 10V, I _D = 1.0A, R _G = 6.2Ω, V _{GS} = 4.5V ② P-Channel V _{DD} = -10V, I _D = -1.0A, R _G = 6.0Ω, V _{GS} = -4.5V ②
			—	5.7	—		
t _{d(on)}	Turn-On Delay Time		—	6.6	—	ns	N-Channel V _{DD} = 10V, I _D = 1.0A, R _G = 6.2Ω, V _{GS} = 4.5V ② P-Channel V _{DD} = -10V, I _D = -1.0A, R _G = 6.0Ω, V _{GS} = -4.5V ②
			—	8.3	—		
t _r	Rise Time		—	1.2	—	ns	N-Channel V _{DD} = 10V, I _D = 1.0A, R _G = 6.2Ω, V _{GS} = 4.5V ② P-Channel V _{DD} = -10V, I _D = -1.0A, R _G = 6.0Ω, V _{GS} = -4.5V ②
			—	14	—		
t _{d(off)}	Turn-Off Delay Time		—	15	—	ns	N-Channel V _{DD} = 10V, I _D = 1.0A, R _G = 6.2Ω, V _{GS} = 4.5V ② P-Channel V _{DD} = -10V, I _D = -1.0A, R _G = 6.0Ω, V _{GS} = -4.5V ②
			—	31	—		
t _f	Fall Time		—	2.4	—	ns	N-Channel V _{DD} = 10V, I _D = 1.0A, R _G = 6.2Ω, V _{GS} = 4.5V ② P-Channel V _{DD} = -10V, I _D = -1.0A, R _G = 6.0Ω, V _{GS} = -4.5V ②
			—	28	—		
C _{iss}	Input Capacitance		—	400	—	pF	N-Channel V _{GS} = 0V, V _{DS} = 15V, f = 1.0MHz P-Channel V _{GS} = 0V, V _{DS} = -15V, f = 1.0MHz
			—	320	—		
C _{oss}	Output Capacitance		—	48	—	pF	N-Channel V _{GS} = 0V, V _{DS} = 15V, f = 1.0MHz P-Channel V _{GS} = 0V, V _{DS} = -15V, f = 1.0MHz
			—	56	—		
C _{rss}	Reverse Transfer Capacitance		—	32	—	pF	N-Channel V _{GS} = 0V, V _{DS} = 15V, f = 1.0MHz P-Channel V _{GS} = 0V, V _{DS} = -15V, f = 1.0MHz
			—	40	—		

Source-Drain Ratings and Characteristics

Parameter	Description		Min.	Typ.	Max.	Units	Conditions
I _S	Continuous Source Current (Body Diode)		—	—	0.96	A	T _J = 25°C, I _S = 0.96A, V _{GS} = 0V ② T _J = 25°C, I _S = -0.96A, V _{GS} = 0V ②
			—	—	-0.96		
I _{SM}	Pulsed Source Current (Body Diode) ①		—	—	11	A	T _J = 25°C, I _S = 0.96A, V _{GS} = 0V ② T _J = 25°C, I _S = -0.96A, V _{GS} = 0V ②
			—	—	-9.0		
V _{SD}	Diode Forward Voltage		—	—	1.2	V	T _J = 25°C, I _S = 0.96A, V _{GS} = 0V ② T _J = 25°C, I _S = -0.96A, V _{GS} = 0V ②
t _{rr}	Reverse Recovery Time		—	25	38	ns	N-Channel T _J = 25°C, I _F = 0.96A, di/dt = 100A/μs P-Channel T _J = 25°C, I _F = -0.96A, di/dt = -100A/μs ②
			—	23	35		
Q _{rr}	Reverse Recovery Charge		—	6.5	9.8	nC	N-Channel T _J = 25°C, I _F = 0.96A, di/dt = 100A/μs P-Channel T _J = 25°C, I _F = -0.96A, di/dt = -100A/μs ②
			—	7.7	12		

Notes:

- ① Repetitive rating; pulse width limited by max. junction temperature. (See fig. 10 & 26)
 ② Pulse width ≤ 400μs; duty cycle ≤ 2%.

- ③ Surface mounted on FR-4 board, t ≤ 10sec.

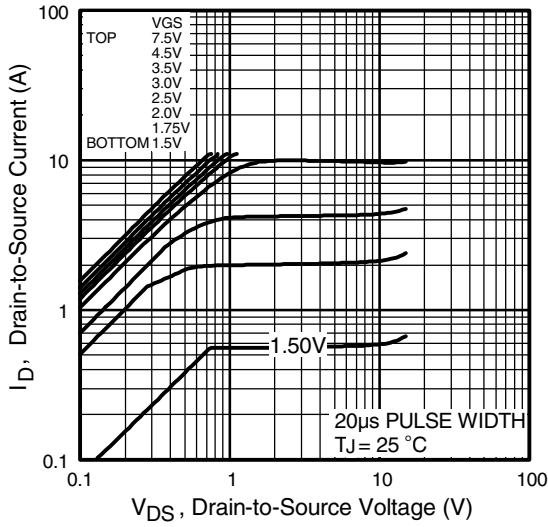

Fig 1. Typical Output Characteristics

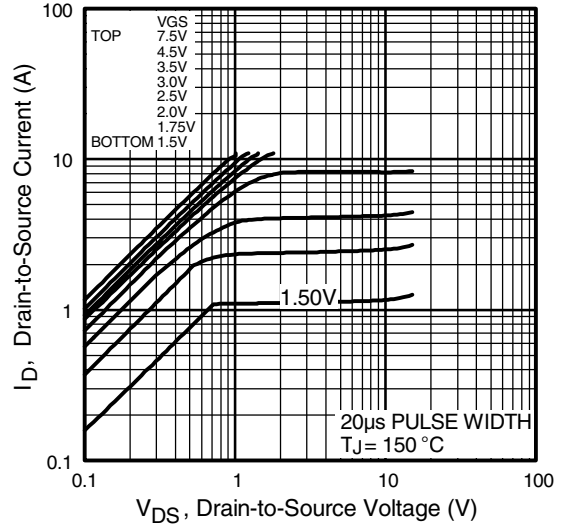

Fig 2. Typical Output Characteristics

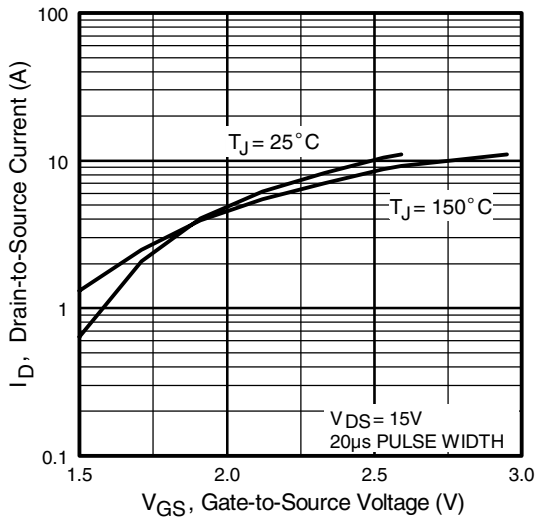

Fig 3. Typical Transfer Characteristics

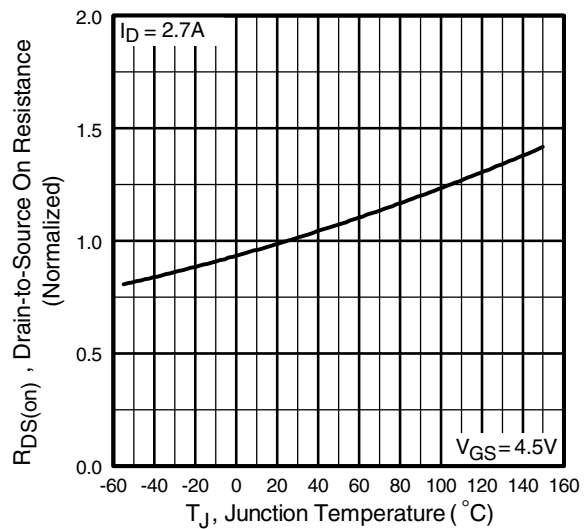

Fig 4. Normalized On-Resistance Vs. Temperature

IRF5851

N-Channel

International
IR Rectifier

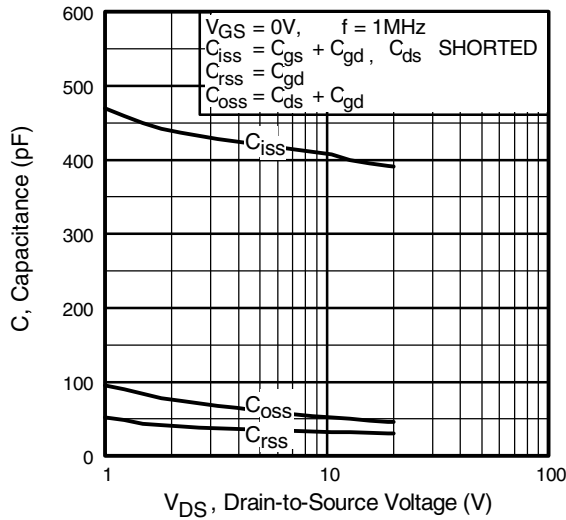

Fig 5. Typical Capacitance Vs. Drain-to-Source Voltage

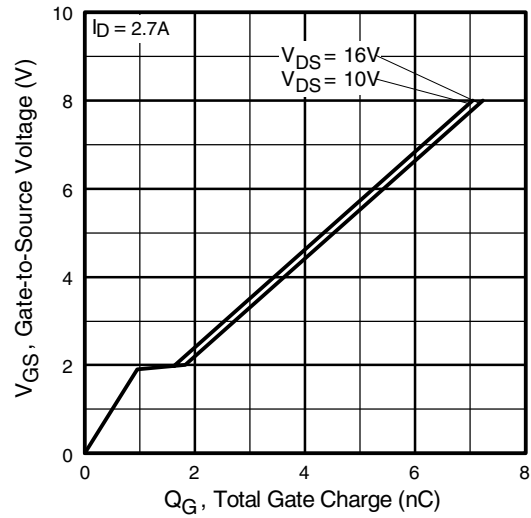

Fig 6. Typical Gate Charge Vs. Gate-to-Source Voltage

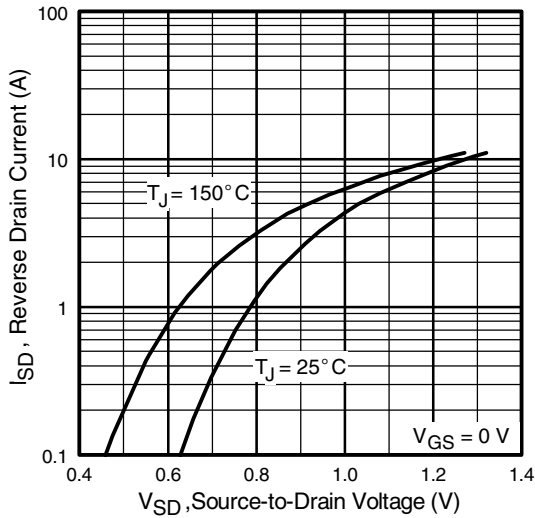

Fig 7. Typical Source-Drain Diode Forward Voltage

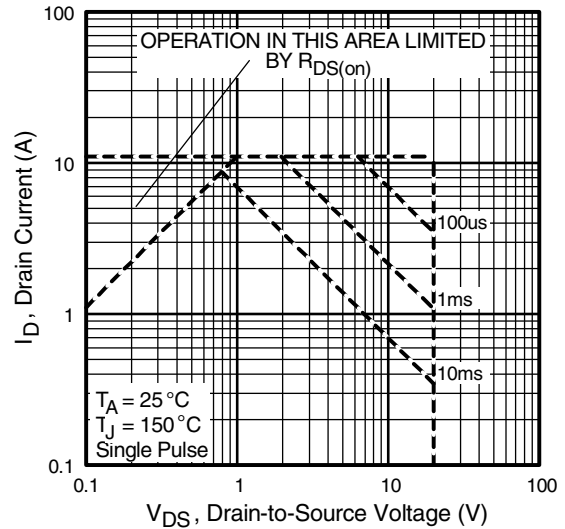

Fig 8. Maximum Safe Operating Area

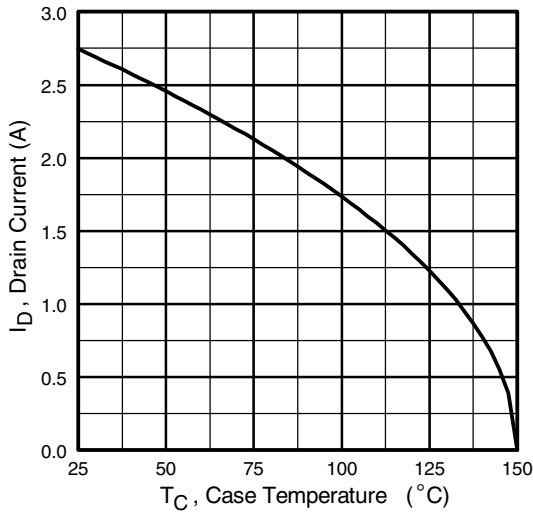

Fig 9. Maximum Drain Current Vs. Case Temperature

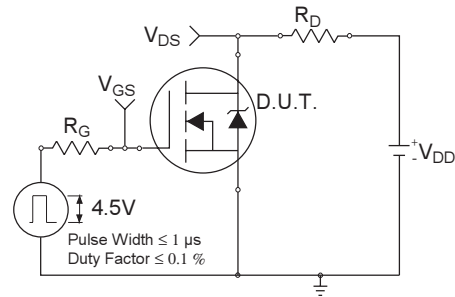

Fig 10a. Switching Time Test Circuit

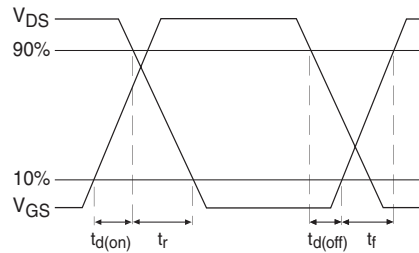

Fig 10b. Switching Time Waveforms

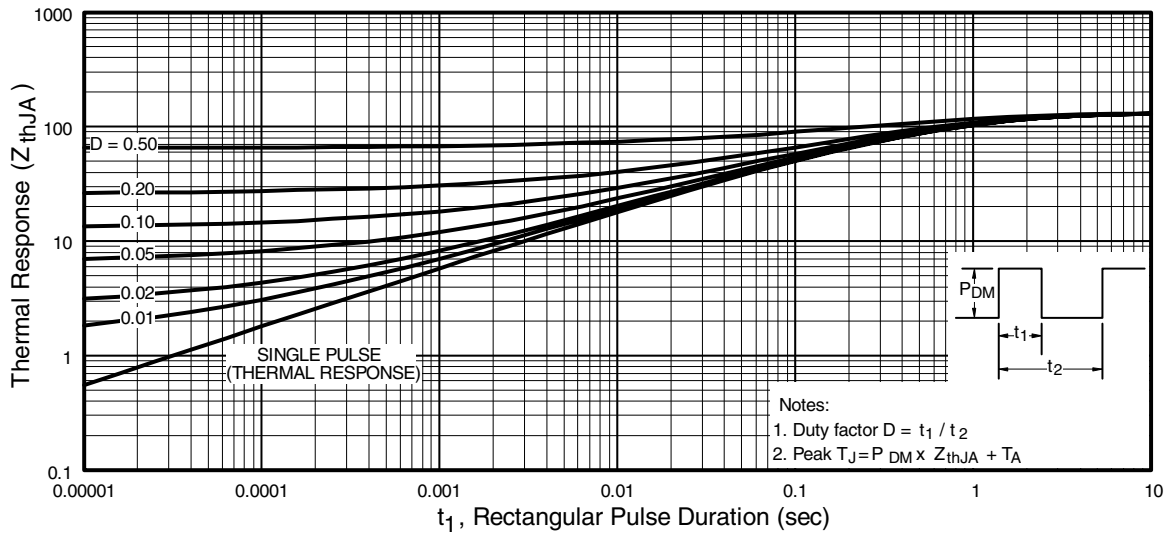

Fig 10. Typical Effective Transient Thermal Impedance, Junction-to-Ambient

IRF5851

N-Channel

International
IR Rectifier

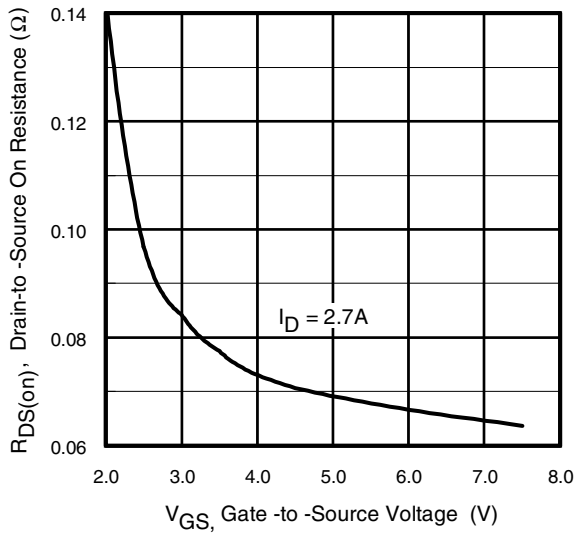

Fig 11. Typical On-Resistance Vs. Gate Voltage

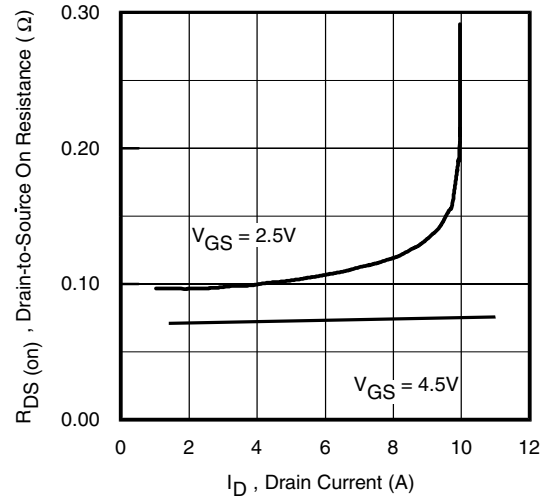

Fig 12. Typical On-Resistance Vs. Drain Current

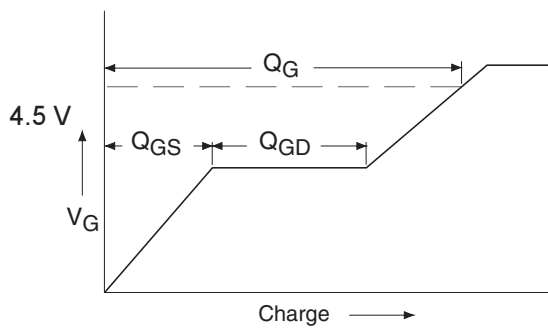

Fig 13a. Basic Gate Charge Waveform

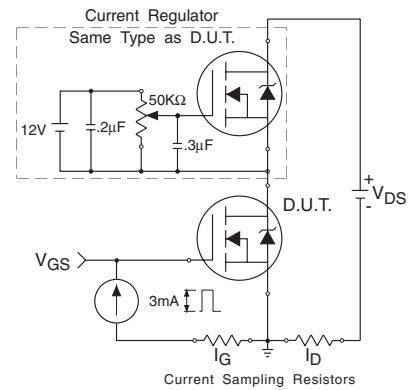

Fig 13b. Gate Charge Test Circuit

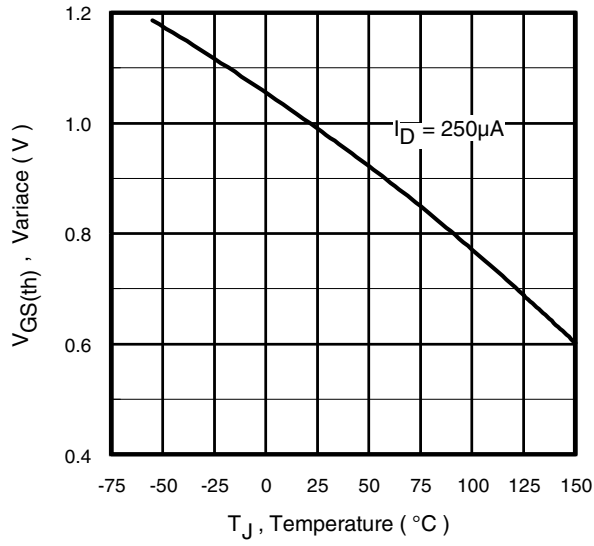

Fig 14. Threshold Voltage Vs. Temperature

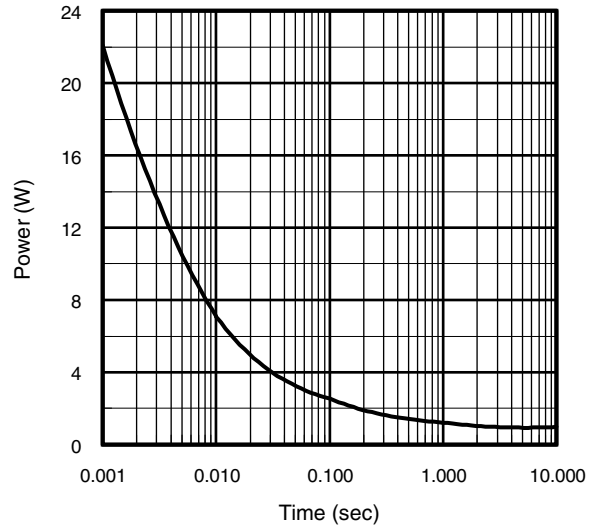

Fig 15. Typical Power Vs. Time

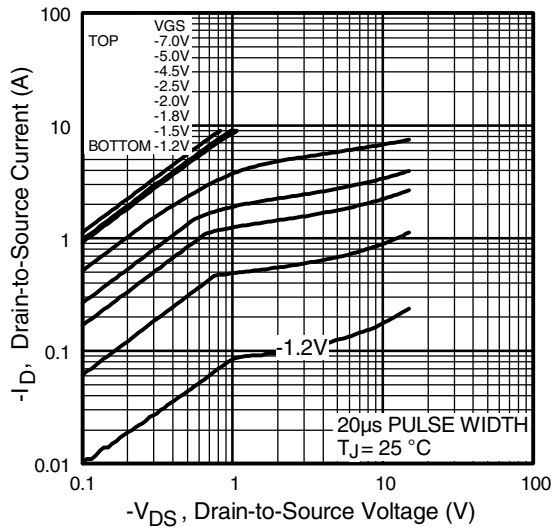

Fig 16. Typical Output Characteristics

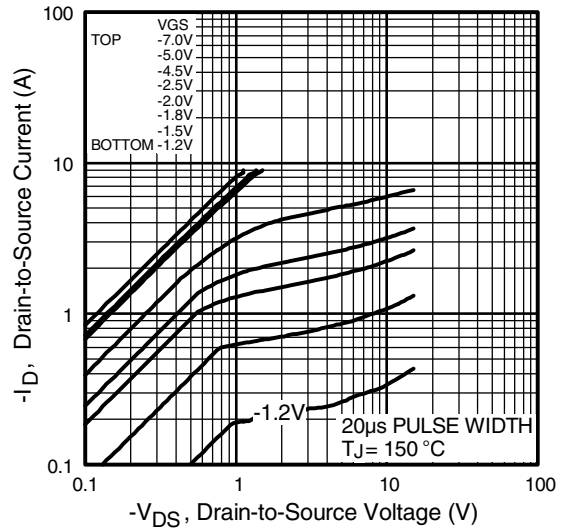

Fig 17. Typical Output Characteristics

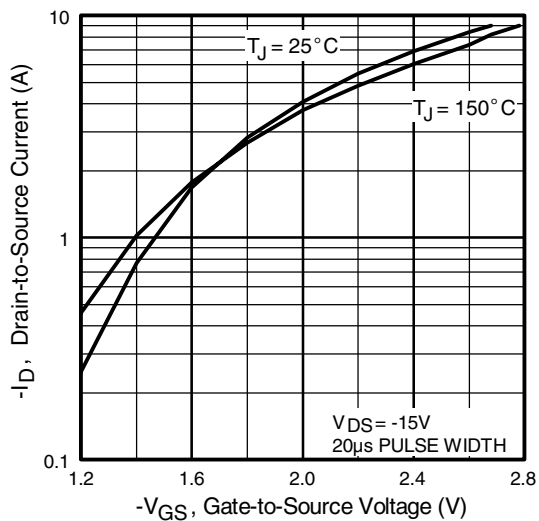

Fig 18. Typical Transfer Characteristics

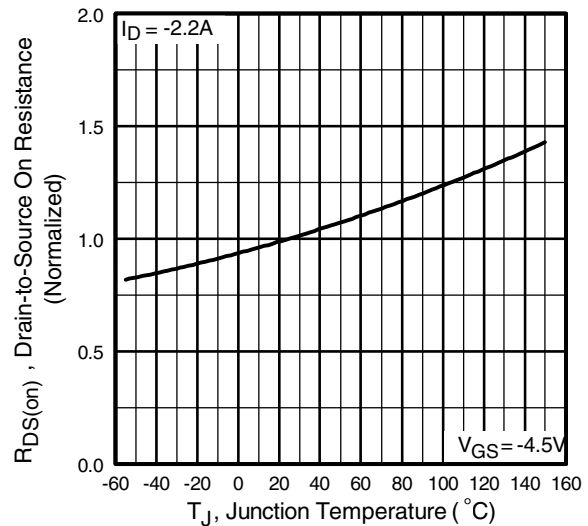

Fig 19. Normalized On-Resistance Vs. Temperature

P-Channel

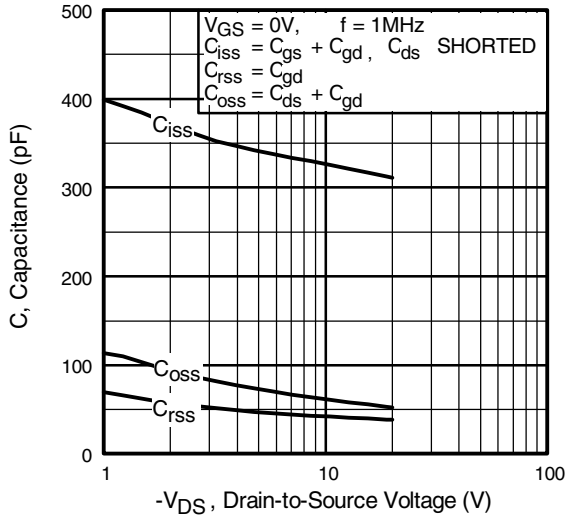

Fig 20. Typical Capacitance Vs. Drain-to-Source Voltage

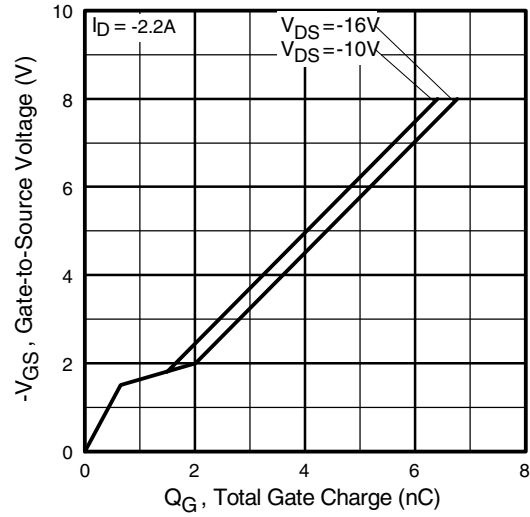

Fig 21. Typical Gate Charge Vs. Gate-to-Source Voltage

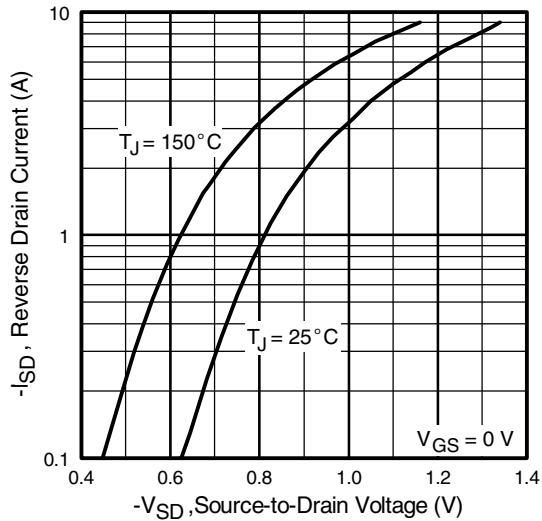

Fig 22. Typical Source-Drain Diode Forward Voltage

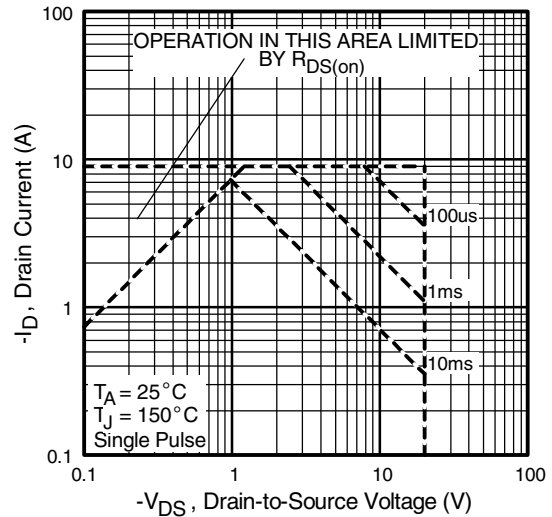

Fig 23. Maximum Safe Operating Area

IRF5851

P-Channel

International
IRF Rectifier

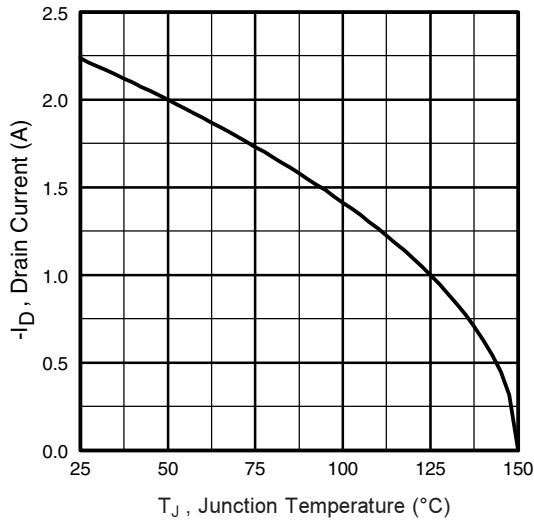

Fig 24. Maximum Drain Current Vs. Junction Temperature

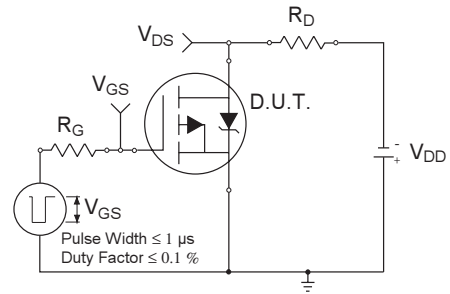

Fig 25a. Switching Time Test Circuit

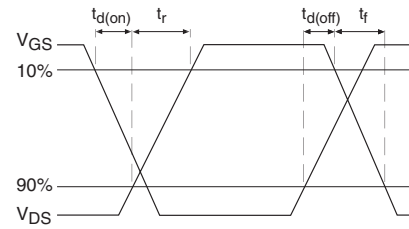

Fig 25b. Switching Time Waveforms

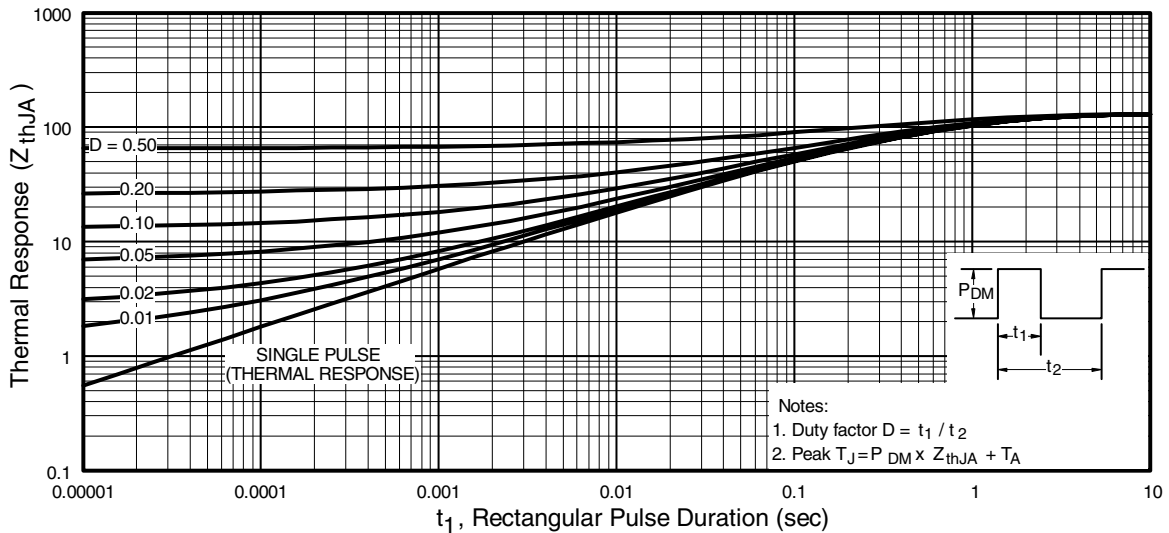

Fig 26. Typical Effective Transient Thermal Impedance, Junction-to-Ambient

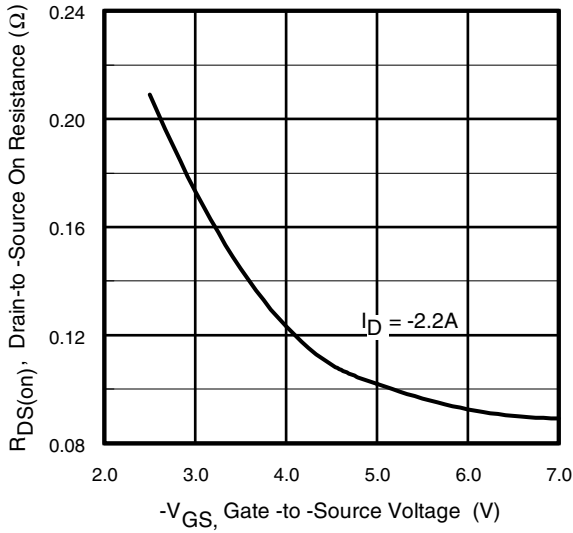

Fig 27. Typical On-Resistance Vs. Gate Voltage

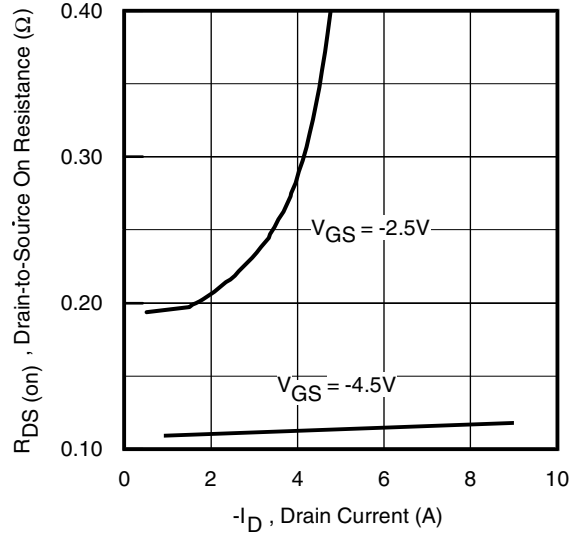

Fig 28. Typical On-Resistance Vs. Drain Current

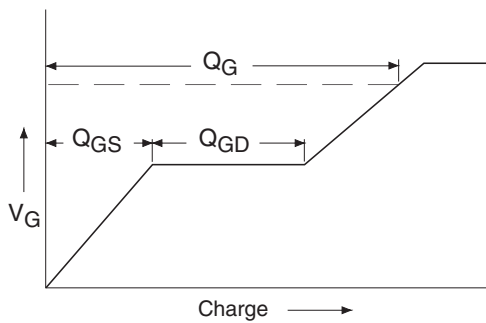

Fig 29a. Basic Gate Charge Waveform

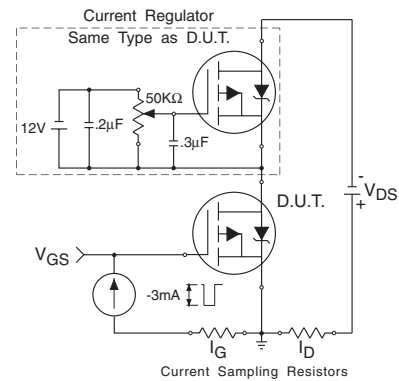

Fig 29b. Gate Charge Test Circuit

IRF5851

P-Channel

International
IR Rectifier

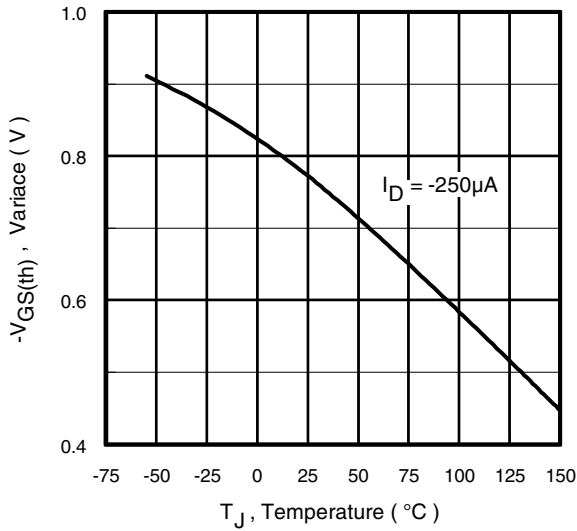

Fig 30. Threshold Voltage Vs. Temperature

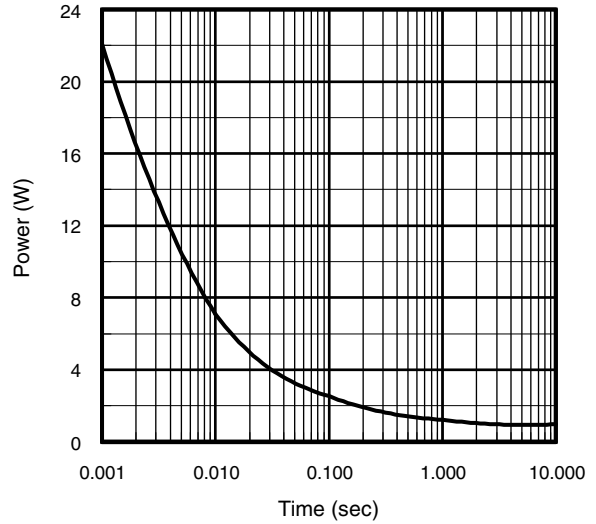
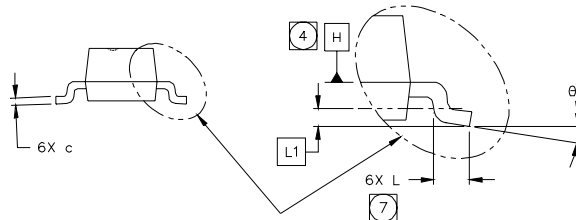
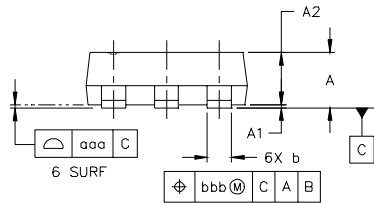
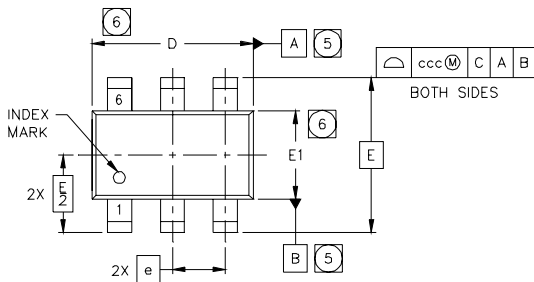

Fig 31. Typical Power Vs. Time

TSOP-6 Package Outline



SYMBOL	MO-193AA DIMENSIONS					
	MILLIMETERS			INCHES		
	MIN	NOM	MAX	MIN	NOM	MAX
A	---	---	1.10	---	---	.0433
A1	0.01	---	0.10	.0004	---	.0039
A2	0.80	0.90	1.00	.0315	.0354	.0393
b	0.25	---	0.50	.0099	---	.0196
c	0.10	---	0.26	.004	---	.010
D	2.90	3.00	3.10	.115	.118	.122
E	2.75 BSC			.108 BSC		
E1	1.30	1.50	1.70	.052	.059	.066
e	1.00 BSC			.039 BSC		
L	0.20	0.40	0.60	.0079	.0157	.0236
L1	0.30 BSC			.0118 BSC		
θ	0°	---	8°	0°	---	8°
aaa	0.10			.004		
bbb	0.15			.006		
ccc	0.25			.010		

TSOP-6 Part Marking Information (Old)

Note: This part marking information applies to devices produced before 02/26/2001.

EXAMPLE: THIS IS AN S13443DV WW = (1-26) IF PRECEDED BY LAST DIGIT OF CALENDAR YEAR

YEAR	Y	WORK WEEK	W
2001	1	01	A
2002	2	02	B
2003	3	03	C
2004	4	04	D
2005	5		
1996	6		
1997	7		
1998	8		
1999	9		
2000	0	24	X
		25	Y
		26	Z

PART NUMBER CODE REFERENCE:

3A = S13443DV
 3B = IRF5800
 3C = IRF5850
 3D = IRF5851
 3E = IRF5852
 3I = IRF5805
 3J = IRF5806

DATE CODE EXAMPLES:
 YWW = 9603 = 6C
 YWW = 9632 = FF

WW = (27-52) IF PRECEDED BY A LETTER

YEAR	Y	WORK WEEK	W
2001	A	27	A
2002	B	28	B
2003	C	29	C
2004	D	30	D
2005	E		
1996	F		
1997	G		
1998	H		
1999	J		
2000	K	50	X
		51	Y
		52	Z

TSOP-6 Part Marking Information (New)

Note: This part marking information applies to devices produced after 02/26/2001.

W = (1-26) IF PRECEDED BY LAST DIGIT OF CALENDAR YEAR

YEAR	Y	WORK WEEK	W
2001	1	01	A
2002	2	02	B
2003	3	03	C
2004	4	04	D
2005	5		
1996	6		
1997	7		
1998	8		
1999	9		
2000	0	24	X
		25	Y
		26	Z

PART NUMBER CODE REFERENCE:

A = S13443DV
B = IRF5800
C = IRF5850
D = IRF5851
E = IRF5852
I = IRF5805
J = IRF5806
K = IRF5810
L = IRF5804
M = IRF5803
N = IRF5820

W = (27-52) IF PRECEDED BY A LETTER

YEAR	Y	WORK WEEK	W
2001	A	27	A
2002	B	28	B
2003	C	29	C
2004	D	30	D
2005	E		
1996	F		
1997	G		
1998	H		
1999	J		
2000	K	50	X
		51	Y
		52	Z

IRF5851

International
IR Rectifier

TSOP-6 Tape & Reel Information

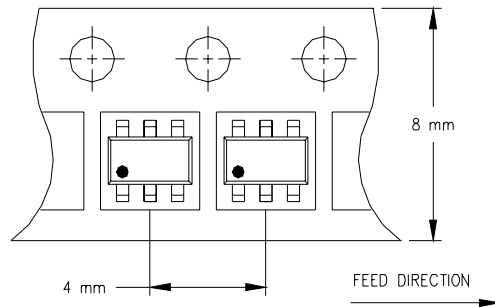

NOTES:

1. OUTLINE CONFORMS TO EIA-481 & EIA-541.

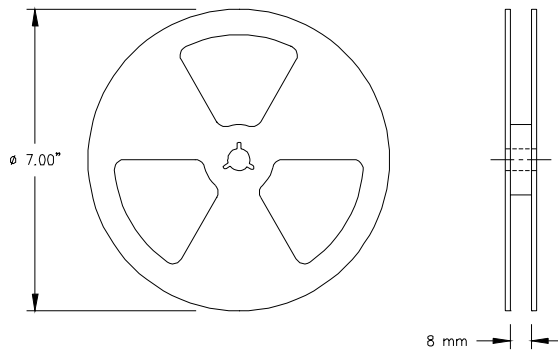

NOTES:

1. OUTLINE CONFORMS TO EIA-481 & EIA-541.

Data and specifications subject to change without notice.
This product has been designed and qualified for the Industrial market.
Qualification Standards can be found on IR's Web site.

International
IR Rectifier

IR WORLD HEADQUARTERS: 233 Kansas St., El Segundo, California 90245, USA Tel: (310) 252-7105
TAC Fax: (310) 252-7903

Visit us at www.irf.com for sales contact information. 09/02